



Developed jet-centrifugal spray devices: experimental testing to establish the possibility of their application in plants spraying technologies

S. Vambol ^a, N.A. Khan ^{b,*}, A.H. Khan ^c, M. Kiriyyenko ^a, L. Borysova ^d,
D. Taraduda ^d, A. Zakora ^d, N. Bilotserkivska ^e

^a Life Safety and Law Department, Kharkiv Petro Vasylenko National Technical University of Agriculture, Kharkiv, Ukraine



^b Civil Engineering Department, Jamia Millia Islamia, New Delhi, India

^c Department of Civil Engineering, Jazan University, 114 Jazan, Saudi Arabia

^d Department of logistics and technical support of rescue operations, National University of Civil Defence of Ukraine, Kharkiv, Ukraine

^e H.S. Skovoroda Kharkiv National Pedagogical University, Kharkiv, Ukraine

* Corresponding e-mail address: er.nadimcivil@gmail.com

ORCID identifier:  <https://orcid.org/0000-0002-8376-9020> (S.V.);  <https://orcid.org/0000-0003-4366-9639> (N.A.K.);  <https://orcid.org/0000-0001-9167-0058> (D.T)

ABSTRACT

Purpose: Experimentally substantiate the possibility of using the developed jet-centrifugal spraying device in plants spraying technologies.

Design/methodology/approach: Many years of experience in creating spraying devices for solving practical problems in various industries made it possible to propose a design diagram of a single-phase jet-centrifugal spraying device. The tests were aimed at achieving device characteristics that are acceptable for use in plants spraying technologies such as jet coverage distance, droplet size and droplet deposition area (spray diameter). For this a several tests series with different design parameters was done. Before testing, the tightness of the device body was checked (the holding time under a pressure of 1 MPa is not less than 2 minutes).

Findings: Based on the obtained jet coverage distance, droplet size and droplet deposition area, the developed spray device of some modifications can be used in plants spraying technologies. However, it is necessary to determine the quality of the spray device according to the BCPC classification; the device should be tested with some insecticides, fungicides and in plants spraying technologies to develop recommendations for their use.

Research limitations/implications: The influence of design features of developed jet-centrifugal spray device on the jet coverage distance, droplet size and droplet deposition area was studied.

Practical implications: The results obtained are useful in the field of improving national plants spraying technologies in order to improve the quality of the plant protection agent application and reduce the loss of the drug into the environment.

Originality/value: To ensure maximum efficiency the proposed design of the jet-centrifugal spray device can be upgraded directly by the farmer by installing interchangeable nozzles that are attached with a union nut. Replaceable nozzles have different diameters and modifications and can be selected depending on the required jet coverage distance and spraying dispersion according to the current environmental conditions.

Keywords: Jet-centrifugal spray device, Experimental testing, Operational characteristics, Plants spraying

Reference to this paper should be given in the following way:

S. Vambol, N.A. Khan, A.H. Khan, M. Kiriyyenko, L. Borysova, D. Taraduda, A. Zakora, N. Bilotserkivska, Developed jet-centrifugal spray devices: experimental testing to establish the possibility of their application in plants spraying technologies, *Journal of Achievements in Materials and Manufacturing Engineering* 102/1 (2020) 30-41. DOI: <https://doi.org/10.5604/01.3001.0014.6326>

MANUFACTURING AND PROCESSING

1. Introduction

An urgent practical problem is the spread of infections in agricultural plants, as a result of which there is a loss of yield [1,2]. Chemicals substances, in particular a plant protection agent, are widely used to control diseases and insects in crops. They should be applied to plants as spray, dust or fog. This requires equipment for uniform and efficient application to eliminate chemicals substances losses and environmental degradation. As a rule, different sprayers' types are used for delivering of active agent liquid to the plants [3-6]. The main function of the sprayer is to break the plant protection agent into effective droplets and distribute them evenly over the surface or protected area [7]. Its other function is to regulate the amount of the active agent liquid to avoid overuse, which can be harmful or wasteful. Herewith methods for delivering of an active agent liquid to

the plants and nozzles design used are of great importance, which must ensure a high degree of deposition efficiency and at the same time exclude excess consumption of the plant protection agent in accordance with the established standards. Deposition efficiency should be understood as adequate coverage of the plant with a protective agent.

It has previously been shown that droplet size distribution has a significant impact on the global efficiency of the deposition process [8]. This is due to the fact that part of the droplets can move due to air currents in the surrounding areas, which leads to the phenomenon of drift [9, 10]. Farmers should select nozzles according to the classification that is based on the British Plant Protection Council (BCPC), that is according to the spray quality (Fig. 1) [11]. When selection is based on spray quality rather than nozzle type, the user has the flexibility to select spray configurations best suited to their local conditions.

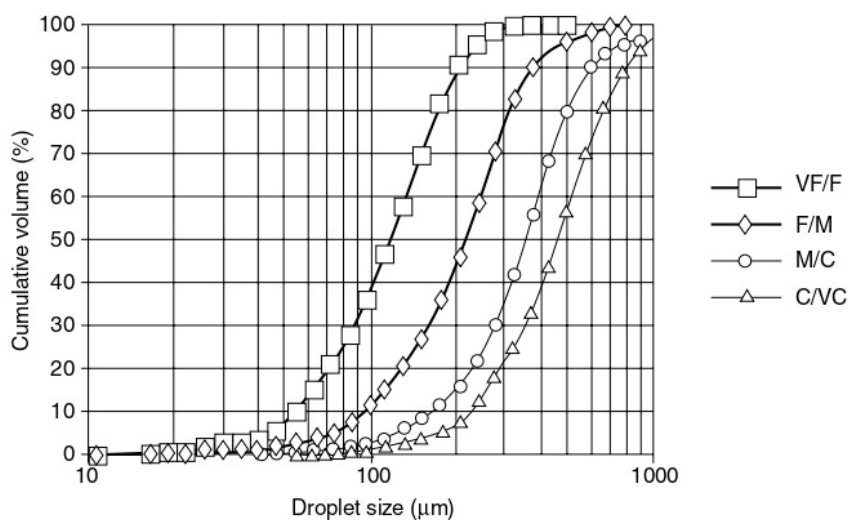

Fig. 1. A BCPC droplet size reference curve [11]

Some companies aim to bring the user to a more efficient sprayer. On the one hand, sprayers and nozzles from well-known manufacturers are expensive for farmers with small land plots in developing countries, including India and Ukraine [5]. As a rule, spraying is traditionally done with a knapsack. Spraying with knapsack sprayers requires human efforts because of the load but also exposes the operator to chemicals. This method takes a long time. According to the surveys conducted, a similar situation, namely a low level of mechanization, exists in other countries of the world [12-15]. Thus, in order to improve the working conditions of farmers and improve agricultural development opportunities in the difficult economic environment in the country, an attempt was made to develop and test a locally produced centrifugal spray device (following Turkey's example [6,16]), which can be easily modified to meet specific tasks in the current environmental conditions.

In this regard, the study purpose is to experimentally substantiate the possibility of using the developed jet-centrifugal spraying device in plants spraying technologies.

2. Materials and methods

When developing the spraying device design, many years of experience in creating similar devices in other areas of technology related to liquid spraying were taken into account [17-21].

2.1. Development of the design of jet-centrifugal spraying device

Many years of experience in creating spraying devices for solving practical problems in various industries made it possible to propose a design diagram of a single-phase jet-centrifugal spraying device shown in Figure 2.

The jet-centrifugal spraying device consists of a cylindrical part, on one side of which there is a fitting for connecting a rubber hose. On the other hand, there is a conical part for placing replaceable nozzles of various diameters on it. The nozzles are fixed to the end of the spray device with a union nut. This design more accurately allows you to adjust the range of the jet and, accordingly, the liquid flow immediately before use, depending on the task. An insert (swirler) with a central hole 6 mm in diameter and grooves located along a generatrix 4 mm wide and 2.5 mm deep is installed in the cylindrical part of the spray gun. Swirler is designed to swirl the flow, increase the diameter of the spray cone and improve dispersion. In order to determine the possible device performance during testing, the variables were the depth, grooves width and the inclination angle. Based on the accumulated experience, the placement of the swirler insert was chosen central, since its location at the end of the conical part (as is done in fire nozzles [22]) does not allow obtaining a sufficiently finely dispersed structure. Since the use of adjustment of the height of the spray device and the angle of the nozzle provides positive results [23], then the spraying device is mounted on a holder with a rod, which provides the ability to spraying device rotate in azimuth and tilt to the horizon.

2.2. Testing

Before testing, the tightness of the device body was checked when the valve was open and the outlet was closed. The holding time under a pressure of 1 MPa is not less than 2 minutes. The quality of the compact jet was controlled visually, namely:

- Formation of a compact jet at the outlet of the nozzle (without grooves, stratification and signs of spraying);
- Uniform distribution of the liquid over the cone of the spray jet.

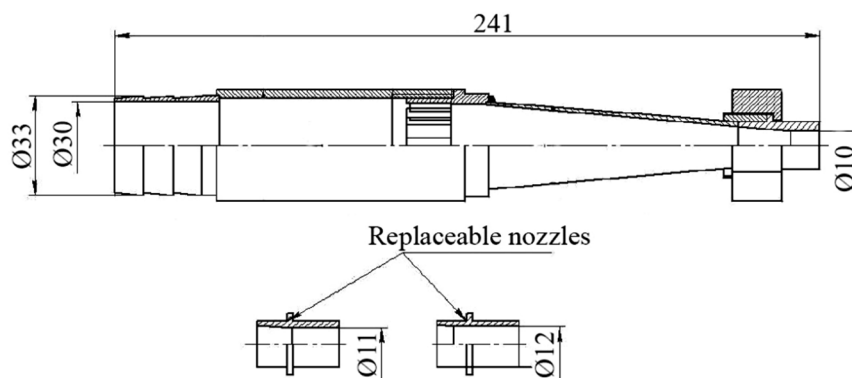

Fig. 2. Structural diagram of the jet-centrifugal spraying device

The tests were aimed at achieving device characteristics that are acceptable for use in plants spraying technologies such as jet coverage distance, droplet size and droplet deposition area (spray diameter).

The liquid flow rate was measured using a DR-20-60Ya42A turbine flow meter. Before installation in the test system, the flow meter was calibrated. Was used a weighting method. The accuracy of determining the flow rate is $\pm 2.5\%$. When measuring the range of a compact jet, the barrel was fixed at an angle of inclination to the horizon ($30^\circ \pm 1$) at a height of (1 ± 0.01) m from the exit cut to the test site. The range (maximum, by extreme drops) of the jet was measured from the projection of the barrel nozzle onto the test site, using pre-installed beacons, using a tape measure in accordance with GOST 7502-98. When determining the range of the jet, the tester was opposite the departure of the jet and set a mark at the point where the extreme drops fell. Measurement accuracy ± 0.2 m.

The droplet size was determined by taking samples from a stream onto glass slides covered with a thin layer of paraffin. The slides were photographed under a microscope (Fig. 3) and the droplet diameter was determined using the software.

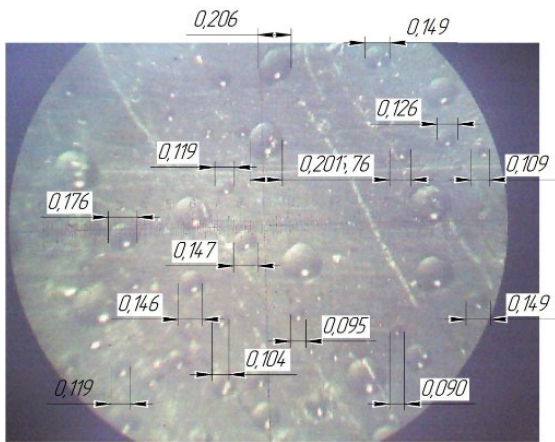

Fig. 3. Seven times magnification of droplets on a microscope slide

2.3. Description of test series

In order to ensure the maximum possible jet coverage distance and spray diameter for droplets of different diameters, seventeen series of tests were carried out with different design parameters of the device. In the present study, only five series are presented in which the most acceptable results were obtained. At the same time, it was expected that some design changes to the device would

provide the required result and would be selected for further testing in plant spraying technologies.

Series 1. During testing, the variable parameter was the diameter of the outlet nozzle, namely, Option 1: $D = 9$ mm; Option 2: $D = 10$ mm; Option 3: $D = 12$ mm with a central body diameter of 7.2 mm.

Series 2. The test was carried out for a jet-centrifugal spraying device with a swirler having grooves 3 mm wide and 5 mm deep along the cylinder generatrix. Tested 3 options for swirlers:

- The angle of inclination of the groove $\alpha = 7^\circ$ with an open central hole;
- The angle of inclination of the groove $\alpha = 6^\circ$ with an open central hole;
- The angle of inclination of the groove $\alpha = 6^\circ$ with a plugged central hole $\varnothing 6$;

Series 3. In this series of tests, the nozzle diameter was 11 mm and the slope of the swirler slots was 4° .

Series 4. In order to increase the range of the jet, the following changes have been introduced into the design of the jet-centrifugal atomizer:

- Insert 30 mm long with peripheral channels at an angle of inclination of 4° to the axis;
- A plate twisted around the longitudinal axis is inserted into the central hole $\varnothing 6$;
- Flat plates 1 mm thick are inserted into the peripheral grooves.

Series 5. Variable parameters were: the peripheral channels inclination angle, the outlet nozzle diameter, and the presence of a swirler in the central hole of the insert. The following versions of the jet-centrifugal spraying device have been tested:

- Option 1: nozzle diameter 11 mm, channel tilt angle 4° , no swirler;
- Option 2: nozzle diameter 10 mm, channel tilt angle 4° , no swirler;
- Option 3: nozzle diameter 12 mm, channel tilt angle 4° , no swirler;
- Option 4: nozzle diameter 10 mm, channel tilt angle 4° , a twisted plate is inserted into the central hole $\varnothing 6$;
- Option 5: the diameter of the nozzle is 10 mm, the angle of inclination of the channels is 6° , and a twisted plate is inserted into the central hole $\varnothing 6$;
- Option 6: nozzle diameter 10 mm, channel tilt angle 7° , a twisted plate is inserted into the central hole $\varnothing 6$;
- Option 7: nozzle diameter 10 mm, channel inclination angle 9° , a twisted plate is inserted into the central hole $\varnothing 6$;
- Option 8: nozzle diameter 11 mm, channel tilt angle 4° , a twisted plate is inserted into the central hole $\varnothing 6$.

3. Results and discussion

Testing of a single-phase jet-centrifugal spraying device

Series 1

The tests of the jet-centrifugal spraying device with different diameters of the outlet nozzle were carried out (Fig. 4).

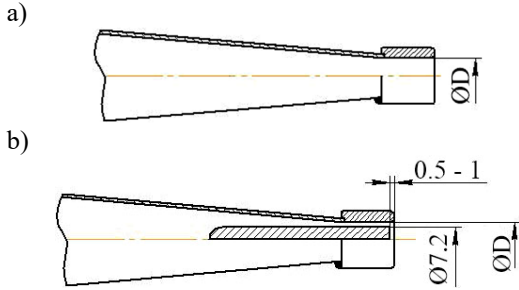

Fig. 4. Constructive options for the spraying device during the tests of Series 1: a) Option 1 and Option 2; b) Option 3

The results of tests of jet-centrifugal spraying device Series 1 are summarized in Table 1 and are presented graphically in Figures 5 and 6.

The spraying device (Fig. 4) provides the narrow stream, insufficient dispersion and a wide range of droplet sizes. With a nozzle diameter of 9 mm (Option 1 of Series 1), the jet coverage distance is the greatest, and the spray diameter is the smallest. The presence of a central body (Option 3 of Series 1) increases the spray diameter, but at the same time reduces the jet coverage distance. No effect on droplet size was observed.

Table 1. Test results of Series 1

No	Liquid pressure, MPa	Liquid consumption, kg/s	Jet coverage distance, m	Spray diameter, mm	Droplet sizes (min-max values), μm
Option 1	0.39	1.55	23	20	352-1364
Option 1	0.49	1.7	25	25	338-1080
Option 1	0.59	1.76	26	30	335-1077
Option 1	0.64	1.81	26.5	35	298-811
Option 2	0.39	1.65	20	25	354-1299
Option 2	0.49	1.87	22	30	343-1011
Option 2	0.59	2.1	24	35	252-922
Option 2	0.61	2.12	25	40	249-741
Option 3	0.39	1.32	18	30	308-1201
Option 3	0.49	1.53	18	40	308-917
Option 3	0.59	1.68	21	50	287-844
Option 3	0.65	1.75	23	60	284-702

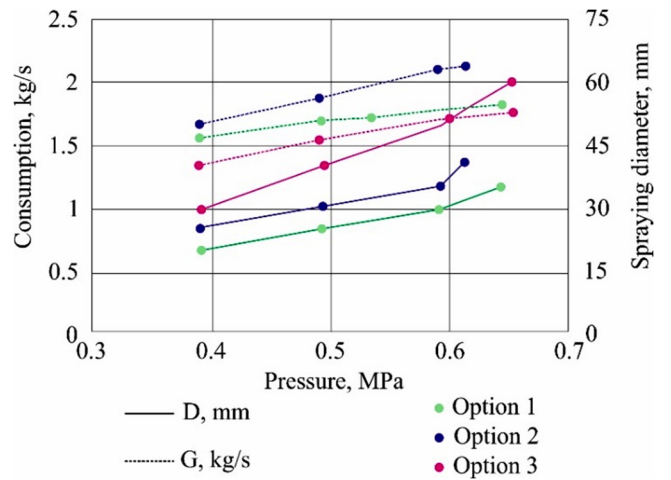

Fig. 5. Liquid flow consumption and spray pattern versus absolute pressure as tested in Series 1

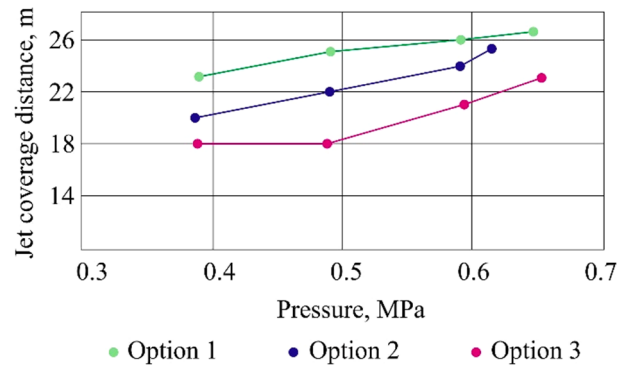

Fig. 6. Jet coverage distance versus absolute pressure as tested in Series 1

Table 2.
Test results of Series 2

No	Liquid pressure, MPa	Liquid consumption, kg/s	Jet coverage distance, m	Spray diameter, mm	Droplet sizes (min-max values), μm
Option 1	0.39	2.22	12	200	215-306
Option 1	0.48	2.47	16	220	61-154
Option 1	0.54	2.58	16	220	43-88
Option 2	0.39	2.2	12	200	202-341
Option 2	0.49	2.47	13	200	38-113
Option 2	0.54	2.62	14	200	33-79
Option 3	0.39	1.83	14	80	354-762
Option 3	0.49	2.11	15	90	273-589
Option 3	0.59	2.36	17	110	209-448

Series 2

Figure 7 shows the jet-centrifugal spraying device with a swirler. In this test series, droplet size reduction expected without loss of jet coverage distance.

The test results are shown in Table 2, and Figures 8 and 9 show graphs corresponding to the data obtained.

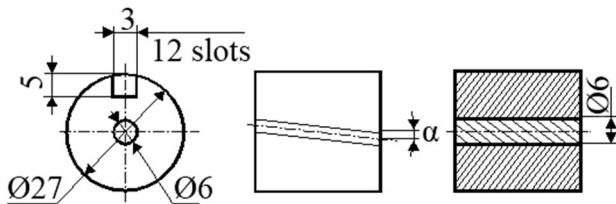

Fig. 7. Design parameters of the Series 2 spraying device

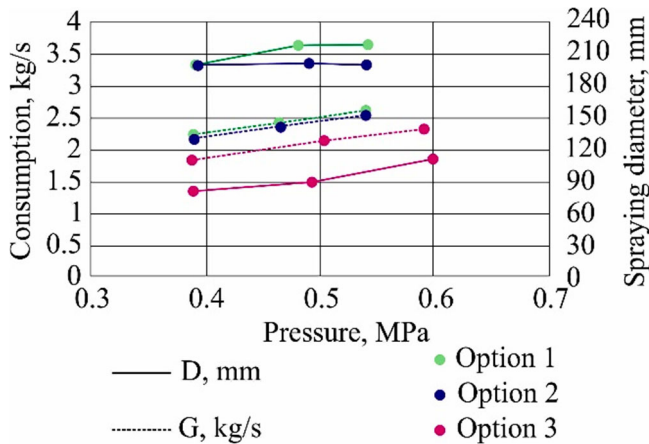

Fig. 8. Liquid flow consumption and spray pattern versus absolute pressure as tested in Series 2

Tests have shown significant change in spray quality. With an increase in swirl (slots' inclination 7°), an increase

in the spray diameter and the decrease in the droplet size are observed. The jet coverage distance is shorter than in the Series 1 tests. The worst case of Series 2 is Option 3, since it showed not very satisfactory results both in terms of spray diameter and droplet sizes.

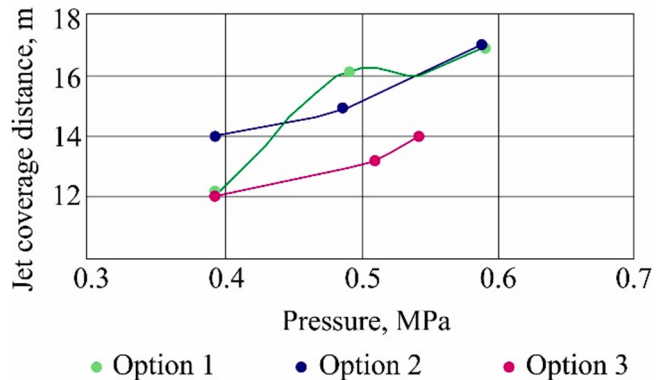

Fig. 9. Jet coverage distance versus absolute pressure as tested in Series 2

Series 3

To increase the jet coverage distance compared to Series 2, the swirl of the flow was reduced to 4°. The spraying device modified design for Series 3 test is shown in Figure 10.

The test results are presented in Table 3.

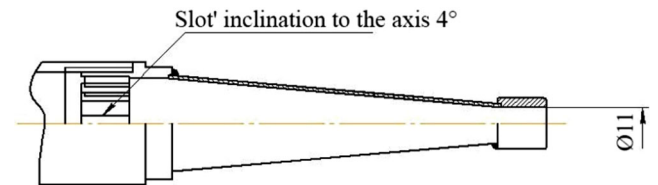

Fig. 10. Design parameters of the Series 3 spraying device

Table 3.
Test results of Series 3

Liquid pressure, MPa	Liquid consumption, kg/s	Jet coverage distance, m	Spray diameter, mm	Droplet sizes (min-max values), μm
0.39	1.88	15	20	351-848
0.49	2.17	16	25	309-653
0.57	2.37	17	30	254-457

Table 4.
Test results of Series 4

No	Liquid pressure, MPa	Liquid consumption, kg/s	Jet coverage distance, m	Spray diameter, mm	Droplet sizes (min-max values), μm
Option 1	0.39	2.32	22	40	209-811
Option 1	0.48	2.77	24	50	199-463
Option 1	0.52	2.8	25	55	128-242
Option 2	0.39	2.39	22	45	201-612
Option 2	0.48	2.71	23	50	157-482
Option 2	0.51	2.81	25	60	83-207
Option 3	0.39	2.3	23	40	122-557
Option 3	0.49	2.66	25	45	91-354
Option 3	0.53	2.81	26	50	68-171

With a decrease in the swirl of the flow to 4° in comparison with the Series 2 tests, a decrease in the spray diameter is observed; the droplets become larger while the jet coverage distance has hardly changed.

Series 4

To increase the jet coverage distance, as well as to provide a small range of droplet sizes, some design improvements were made again and three modifications were presented for the Series 4 tests. The spraying device modified design for Series 4 test is shown in Figure 11.

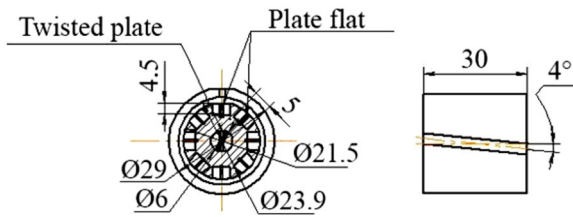

Fig. 11. Design parameters of the Series 4 spraying device

The test results are presented in Table 4 and Figure 12, 13. This test series demonstrates a significant increase in jet coverage distance with decreasing spray diameter. The jet is uniform, at a pressure of 0.52 MPa (Option 1 of Series 4), 0.51 MPa (Option 2 of Series 4) and 0.53 MPa (Option 3 of Series 4), a small range of droplet sizes is observed, and, therefore, the droplet spectrum is more uniform, which increases the efficiency of droplet control.

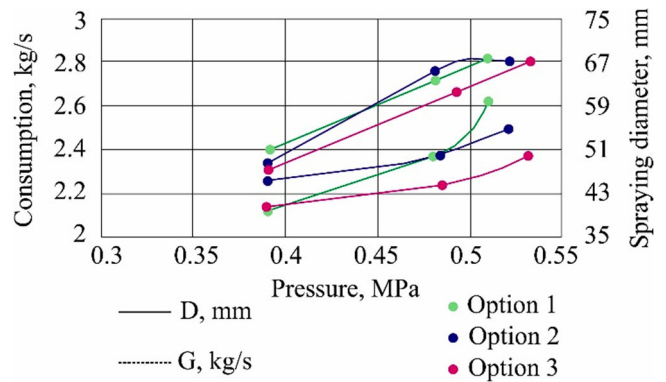

Fig 12. Liquid flow consumption and spray pattern versus absolute pressure as tested in Series 4

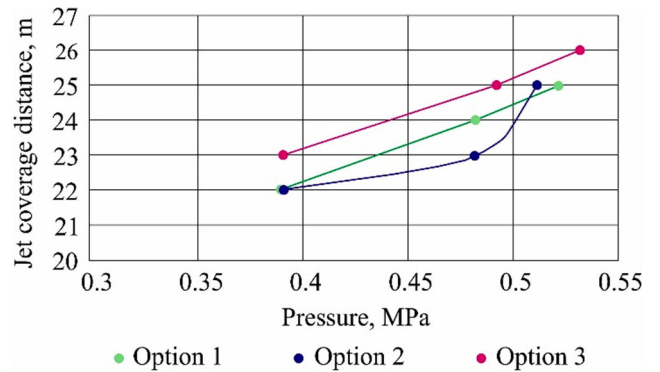

Fig. 13. Jet coverage distance versus absolute pressure as tested in Series 4

Series 5

The spraying device modified design for Series 5 test is shown in Figure 14.

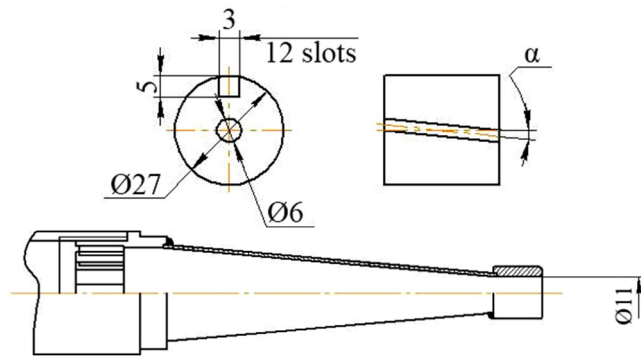

Fig. 14. Design parameters of the Series 5 spraying device

The test results are presented in Table 5.

The test results showed good spray quality in Option 2 of Series 5 with a nozzle diameter of 10 mm. Option 2 of Series 5 provides a good jet coverage distance of 17-20 m and good dispersion 43-117 μm with a small range of droplet diameters. Also, good results were obtained in Option 8 of Series 5 when the swirler plate was installed in the central hole and the nozzle diameter was 11 mm. In this variant, the jet coverage distance is less than in Option 2 of Series 5 and is 15-17 m, but at the same time the spray diameter is more than 110-170 mm (compared to 60-80 mm in Option 2 of Series 5) as well as droplets size and the range of droplet diameters is smaller, which is 27-88 μm . Also noteworthy is the test of the Option 4 of Series 5 device at a pressure of 0.57 MPa. This option provides a jet coverage distance close to 20 m, dispersion 65-150 μm (this is comparable to the dispersion of Option 2 of Series 5 and slightly exceeds the dispersion of Option 8 of Series 5) and the spray diameter of 160 mm (in contrast to Option 2 of Series 5 where the scattering diameter is 60-80 mm).

Table 5.
Test results of Series 5

No	Liquid pressure, MPa	Liquid consumption, kg/s	Jet coverage distance, m	Spray diameter, mm	Droplet sizes (min-max values), μm
Option 1	0.39	2.12	25	40	221-650
Option 1	0.49	2.47	23	50	203-554
Option 1	0.54	2.63	26	60	151-508
Option 2	0.39	1.9	16	30	202-457
Option 2	0.49	2.04	17	60	48-117
Option 2	0.59	2.26	20	80	43-105
Option 3	0.39	2.49	24	40	205-443
Option 3	0.49	2.86	26	40	181-304
Option 3	0.51	2.87	27	40	156-251
Option 4	0.39	1.94	17	100	169-273
Option 4	0.49	2.15	18	120	108-211
Option 4	0.57	2.41	20	160	65-150
Option 5	0.39	1.9	15	100	122-257
Option 5	0.49	2.24	17	120	86-209
Option 5	0.57	2.41	18	160	65-155
Option 6	0.39	1.95	13	170	114-207
Option 6	0.49	2.25	14	200	71-178
Option 6	0.57	2.44	15	220	54-157
Option 7	0.39	1.96	14	200	49-181
Option 7	0.49	2.26	15	250	45-159
Option 7	0.56	2.44	16	250	42-122
Option 8	0.39	1.89	15	110	47-88
Option 8	0.49	2.17	16	130	37-86
Option 8	0.57	2.38	17	170	27-78

It is known that reducing droplet size improves overall coverage by increasing the droplets number, and the efficiency of plants spray treatment can be improved by reducing droplet size, which increases the density of the droplets, and therefore improves spray application to the target [24].

At the same time, modern experience with spray application technology shows that the diameter of a droplet determines the final velocity or deposition rate at which it falls to the target (in the absence of wind). For example, a 250 μm droplet has a settling velocity of about 1 m/s and will therefore fall to the ground from most spray devices within seconds of being released. However, a 100 μm droplet has a deposition rate of 0.25 m/s and can be subject to significant drift. Such droplets can settle several hundred meters from the target area. This distance depends on the drop formation height and wind speed. A drop of 10 μm has a deposition rate of 0.003 m/s and can be considered as being practically in the air. A few droplets 10 μm in size or the size of an aerosol may end up settling on fine surfaces such as hair, but most of them, due to evaporation, will eventually become residual particles and are lost to the atmosphere [11]. The evaporation rate of a drop depends on its size. Experiments have shown that water droplets less than 150 μm in size evaporate about 27% faster than droplets larger than this size. This is due to the change in airflow that occurs with smaller droplets. More than 150 μm , the air flow is separated from the base of the droplet, and evaporation from this area does not occur. In contrast, the flow is attached everywhere on droplets less than 150 μm in size, and evaporation occurs from the entire surface [25].

For better plant protection agent deposition the authors of [26] recommend reducing the loss of fungicides and insecticides by avoiding very small droplets that are prone to drift and evaporation, and very large droplets that run off the leaves and pollute the soil.

In [7], the following Optimum Droplet Sizes for Different Targets (Tab. 6).

Table 6.

Optimum droplet sizes for different targets [7]

Target type	Droplet sizes, μm
Flying insects (drift)	10-15
Crawling and sucking insect (drift)	30-50
Plant surfaces (limited drift)	60-150

Based on the foregoing, according to the test results, the device designs presented in Table 7 are promising.

Series 3 modification can be used to spray broadleaf plants as droplets of this size, due to their greater mass and fall rate, tend to settle quickly on horizontal surfaces near their point of release [11]. Other device modifications can be used to spray crops such as cotton, corn, sunflower, millet, etc. [7,24]. The main advantage of these modifications is the narrow droplet size range. The smaller the droplet diameters range, the more uniform the droplet spectra. Unfortunately, none of the practical nozzles produces the same droplet size. All commercial nozzles produce different droplet sizes. [11].

The droplet size, its initial velocity, evaporation rate and meteorological conditions all affect the droplet movement through the air. [27]. Wind speed and movement have a clear influence on spray drift, namely the higher the speed, the greater the spray drift, for both air drift and target deposits [28-30]. One of the important technical factors influencing spray drift is the percentage of small spray droplets [31-34]. The smaller the droplet size, the longer it remains in the air and the higher the probability of being carried away by a side wind [35]. Droplets less than 100 μm in diameter make a significant contribution to drift losses [36,37], to avoid which the correct deposition strategy must be chosen [7,24].

The jet coverage distance is of great importance, since if the jet coverage distance is greater, then there is no need to use bulky boom sprayers [35,38]. In addition, the problems of asynchronous operation, poor stability of the sprayer boom and high production costs are known [39,40].

Table 7.

The device constructive modifications, which are selected for further testing, and their parameters

The device constructive modifications	Liquid pressure, MPa	Jet coverage distance, m	Spray diameter, mm	Droplet sizes (min-max values), μm
Series 3	0.57	17	30	254-457
Series 4, Option 2	0.51	25	60	83-207
Series 5, Option 2	0.49	17	60	48-117
Series 5, Option 2	0.59	20	80	43-105
Series 5, Option 4	0.57	20	160	65-150
Series 5, Option 8	0.49	16	130	37-86
Series 5, Option 8	0.57	17	170	27-78

Therefore, for further tests, spraying device modifications of the with the greatest jet coverage distance while ensuring other acceptable parameters were selected. Due to the fact that an increase in the jet coverage distance leads to a jet narrowing, it is logical to use azimuthal scanning of the sprayed area by rotating the spraying device. To implement this possibility, a holder design similar to that for fixing the telescope [41,42] can be recommended. It is important that this design allows for vertical lift and azimuth rotation of the spray device. The spraying device can be mounted on any transport; both ground (car, tractor, cart, etc.) and air (small airplanes or UAVs). However, with increasing jet coverage distance, the likelihood in drift losses also increases, which, as a rule, occurs at small and medium drops [43]. This can lead to a decrease in the effectiveness of the phytosanitary treatment and an increase in negative environmental impact [44] and that would contradict the land legislative acts [45]. Therefore, further research is needed to establish the quality category of the spraying device in accordance with the BCPC classification (Fig. 1) [11] and develop recommendations for the application technology.

4. Conclusions

Thus, it is clear from the study results that:

- 1) Based on the obtained jet coverage distance, droplet size and droplet deposition area, the developed spray device of some modifications can be used in plants spraying technologies.
- 2) To ensure maximum convenience and economy the proposed design of the spraying device can be upgraded directly by the farmer by installing interchangeable nozzles that are attached with a union nut. Replaceable nozzles have different diameters and modifications as shown in Series 1-5 tests and can be selected depending on the required jet coverage distance and spraying dispersion according to the current environmental conditions.
- 3) At the same time, these results are not enough to recommend the device for use. For the most promising injectors selected in this study, the following tests should be performed:
 - the device must be tested with some insecticides, fungicides, since this study presents tests with water, and the physical properties of the plant protection agent (density, viscosity, etc.) may differ from water properties. You should also remember about safety during research and use of plant treatment products, since maintaining health is the main priority in the work [46];
 - it is necessary to determine the quality of the spray device in accordance with the BCPC classification, that is, it is necessary to determine the percentage of uniform droplets;
 - it is necessary to test the device in plants spraying technologies and develop recommendations for their use.

Only on the basis of the results of the above tests can the device be recommended or not recommended for use in plants spraying technologies.

Acknowledgements

The authors are very thankful and acknowledge to administration of Kharkiv Petro Vasylenko National Technical University of Agriculture, Jamia Millia Islamia and administration of other institutions, which authors represent.

References

- [1] W.A. Shands, G.W. Simpson, Spraying potatoes to prevent leaf roll spread by the green peach aphid, *American Potato Journal* 49/1 (1972) 23-34. DOI: <https://doi.org/10.1007/BF02862938>
- [2] P.K. Roy, X.Z. Li, F.A. Basir, A. Datta, J. Chowdhury, Effect of insecticide spraying on *Jatropha curcas* plant to control mosaic virus: a mathematical study, *Communications in Mathematical Biology and Neuroscience* 2015 (2015) 36.
- [3] H. Dou, C. Zhang, L. Li, G. Hao, B. Ding, W. Gong, P. Huang, Application of variable spray technology in agriculture, *IOP Conference Series: Earth and Environmental Science* 186/5 (2018) 012007. DOI: <https://doi.org/10.1088/1755-1315/186/5/012007>
- [4] A.I. Belousova, A.V. Moiseev, D.A. Fillipov, Design of a sprayer for complex treatment of tilled crops, *E3S Web of Conferences* 126 (2019) 00013. DOI: <https://doi.org/10.1051/e3sconf/201912600013>
- [5] S. Singh, D. Padhee, S. Sonwani, T. Sahu, Design, Fabrication and Evaluation of Wheel Operated Sprayer, *International Journal of Current Microbiology and Applied Sciences* 9/1 (2020) 1649-1659. DOI: <https://doi.org/10.20546/ijcmas.2020.901.182>
- [6] A. Bayat, M. Itmec, The current state of sprayer manufacturers in Turkey and some strategies for the future, *Scientific Papers. Series A: Agronomy* 61/2 (2018) 121-125.
- [7] Farmers' Portal, Plant protection equipment. Available from: <https://farmer.gov.in/dacddivision/Machinery1/chap4.pdf>

- [8] G. Matthews, Pesticide application methods, Third Edition, John Wiley & Sons, London, UK, 2008.
- [9] M. Nițu, M. Matache, A. Pruteanu, I. Găgeanu, A. Matache, D. Dumitru, F. Sirbu, Aspects on the construction and operation of spraying equipment for reducing drift in field crops, *Annals of the University of Craiova – Agriculture, Montanology, Cadastre Series* 48/2 (2019) 357-366.
- [10] W. Stahli, S. Bungescu, Devices, equipment and machines for plant protection, *Agroprint Usamvbt Pub., Timișoara*, 2006.
- [11] Primary Industries Standing Committee, Spray drift management: principles, strategies and supporting information, Series: Primary Industries Report Series, Report no. 82, CSIRO Publishing, 2020. Available from: <https://www.publish.csiro.au/book/3452/#details>
- [12] K. Remoundou, M. Brennan, G. Sacchetti, L. Panzone, M.C. Butler-Ellis, E. Capri, A. Charistou, E. Chaideftou, M.G. Gerritsen-Ebben, K. Machera, P. Spanoghe, R. Glass, A. Marchis, K. Doanngoc, A. Hart, L.J. Frewer, Perceptions of pesticides exposure risks by operators, workers, residents and bystanders in Greece, Italy and the UK, *Science of the Total Environment* 505 (2015) 1082-1092. DOI: <https://doi.org/10.1016/j.scitotenv.2014.10.099>
- [13] E. Lichtenberg, R. Zimmerman, Information and farmers' attitudes about pesticides, water quality, and related environmental effects, *Agriculture, Ecosystems & Environment* 73/3 (1999) 227-236. DOI: [https://doi.org/10.1016/S0167-8809\(99\)00053-5](https://doi.org/10.1016/S0167-8809(99)00053-5)
- [14] E. Cerruto, G. Manetto, F. Santoro, S. Pascuzzi, Operator dermal exposure to pesticides in tomato and strawberry greenhouses from hand-held sprayers, *Sustainability* 10/7 (2018) 2273. DOI: <https://doi.org/10.3390/su10072273>
- [15] D.J. Snelder, M.D. Masipiqueña, G.R. De Snoo, Risk assessment of pesticide usage by smallholder farmers in the Cagayan Valley (Philippines), *Crop Protection* 27/3-5 (2008) 747-762. DOI: <https://doi.org/10.1016/j.cropro.2007.10.011>
- [16] M. İtmeç, A. Bayat, Modal Analysis of Different Boom Designs of Field Sprayers with a CAD Program, Proceedings of the 1st International Congress on Biosystems Engineering "ICOBEN2019", Antakya, Hatay, Turkey, 2019, 114. Available form: <http://icoben2019.mku.edu.tr/files/2019-12-ICOBEN2019-Proceeding-E-book-2-final.pdf#page=117>
- [17] S. Vambol, V. Vambol, K.A.H. Al-Khalidy, Experimental study of the effectiveness of water-air suspension to prevent an explosion, IOP Conference Series: Journal of Physics 1294/7 (2019) 072009. DOI: <https://doi.org/10.1088/1742-6596/1294/7/072009>
- [18] R.A. Berube, Effective temperature control for cement kiln off-gases, *World Cement* 27/3 (1996) 77-82. Available form: <http://www.cheresources.com/cementkiln.shtml>
- [19] S. Vambol, Y. Shakhov, V. Vambol, I. Petukhov, A mathematical description of the separation of gas mixtures generated by the thermal utilization of waste, *Eastern-European Journal of Enterprise Technologies* 2/79 (2016) 35-41. DOI: <https://doi.org/10.15587/1729-4061.2016.60486>
- [20] S.O. Vambol, N.V. Kobrina, O.O. Trukhmayev, Systema upravlinnya ekolohichnoyu bezpekoyu pry vykorystanni pylopryhnychuyuchykh system zroshennya u protsesi navantazhennya ta rozvantazhennya spykykh materialiv u portakh, *Otkrytye Ynformatsyonnye y Komp'yuternye Yntehyrovannye Tekhnolohyy* 55 (2012) 161-167.
- [21] V. Vambol, S. Vambol, O. Kondratenko, V. Koloskov, Y. Suchikova, Substantiation of expedience of application of high-temperature utilization of used tires for liquefied methane production, *Journal of Achievements in Materials and Manufacturing Engineering* 87/2 (2018) 77-84. DOI: <https://doi.org/10.5604/01.3001.0012.2830>
- [22] I.A. Lepeshinskiy, Novaya tekhnologiya polucheniya gazokapel'nykh struy i systemy pozharotusheniya na yeye osnove, *Konversiya v Mashinostroyenii* 1-2 (2005) 117-123.
- [23] V.K. Tewari, A.K. Chandel, B. Nare, S. Kumar, Sonar sensing predicated automatic spraying technology for orchards. *Current Science* 115/6 (2018) 1115-1123. DOI: <https://doi.org/10.18520/cs/v115/i6/1115-1123>
- [24] K.J. Ahmed, Q. Ali, I. Nadeem, M.F. Akhtar, N.A. Anjum, A. Abbas, M.K. Hanif, Comparative effectiveness of different sprayers against cotton whitefly (*Bemisia Tabaci* Genn.), *Journal of Agricultural Research* 58/1 (2020) 9-12.
- [25] J.J. Spillman, Evaporation from freely falling droplets, *The Aeronautical Journal* 88/875 (1984) 181-185. DOI: <https://doi.org/10.1017/S0001924000020479>
- [26] J.R. di Oliveira, M.D.C. Ferreira, R.A. Román, Diferentes diâmetros de gotas e equipamentos para aplicação de inseticida no controle de *Pseudoplusia includens*, *Engenharia Agrícola* 30/1 (2010) 92-99. DOI: <https://doi.org/10.1590/S0100-69162010000100010>
- [27] M.E. Teske, J.W. Barry, B. Richardson, An FSCBG sensitivity study for decision support systems, Proceedings of the ASAE Annual Meeting, Phoenix, AZ, USA, 1996, 961037.
- [28] J.C. Van de Zande, H. Stallinga, J.M.G.P. Michielsen, P. Van Velde, Effect of sprayer speed on spray drift,

- Annual Review of Agricultural Engineering 4/1 (2005) 129-142.
- [29] S. Chen, Y. Lan, J. Li, X. Xu, Z. Wang, B. Peng, Evaluation and test of effective spraying width of aerial spraying on plant protection UAV, Transactions of the Chinese Society of Agricultural Engineering 33/7 (2017) 82-90. DOI: <https://doi.org/10.11975/j.issn.1002-6819.2017.07.011>
- [30] J.D. Cavalieri, C.G. Raetano, R.P. Madureira, L.L. Moreira, Spraying systems and traveling speed in the deposit and spectrum of droplets in cotton plant, Engenharia Agrícola 35/6 (2015) 1042-1052. DOI: <https://doi.org/10.1590/1809-4430-Eng.Agric.v35n6p1042-1052/2015>
- [31] T. Arvidsson, L. Bergström, J. Kreuger, Spray drift as influenced by meteorological and technical factors, Pest Management Science 67/5 (2011) 586-598. DOI: <https://doi.org/10.1002/ps.2114>
- [32] D. Nuyttens, M. De Schampheleire, P. Verboven, B. Sonck, Comparison between indirect and direct spray drift assessment methods, Biosystems Engineering 105/1 (2010) 2-12. DOI: <https://doi.org/10.1016/j.biosystemseng.2009.08.004>
- [33] D. Nuyttens, M. De Schampheleire, K. Baetens, E. Brusselman, D. Dekeyser, P. Verboven, Drift from field crop sprayers using an integrated approach: results of a five-year study, Transactions of the ASABE 54/2 (2011) 403-408.
- [34] A. Miranda-Fuentes, P. Marucco, E.J. González-Sánchez, E. Gil, M. Grella, P. Balsari, Developing strategies to reduce spray drift in pneumatic spraying in vineyards: Assessment of the parameters affecting droplet size in pneumatic spraying, Science of the Total Environment 616-617 (2018) 805-815. DOI: <https://doi.org/10.1016/j.scitotenv.2017.10.242>
- [35] H. De Ruiter, H.J. Holterman, C. Kempenaar, H.G.J. Mol, J.J. de Vlieger, J. van de Zande, Influence of Adjuvants and Formulations on the Emission of Pesticides to the Atmosphere, A Literature Study for the Dutch Research Programme Pesticides and the Environment (DWK) Theme C-2, Plant Research International B.V.: Wageningen, The Netherlands, 2003, Report 59.
- [36] P.A. Hobson, P.C.H. Miller, P.J. Walklate, C.R. Tuck, N.M. Western, Spray drift from hydraulic spray nozzles: the use of a computer simulation model to examine factors influencing drift, Journal of Agricultural Engineering Research 54/4 (1993) 293-305. DOI: <https://doi.org/10.1006/jaer.1993.1022>
- [37] P. Miller, The measurement of spray drift, Pesticide Outlook 14/5 (2003) 205-209. DOI: <https://doi.org/10.1039/B311466J>
- [38] C. Stainier, M.F. Destain, B. Schiffers, F. Lebeau, Effect of the entrained air and initial droplet velocity on the release height parameter of a Gaussian spray drift model, Communications in Agricultural and Applied Biological Sciences 71/2A (2006) 197-200.
- [39] Y. Song, L.J. Zhang, W.N. Chen, Y.K. Li, Design and Experiment of A New Boom Sprayer Extending and Folding Mechanism, Journal of Shenyang Agricultural University 2 (2018) 8.
- [40] P. Balsari, E. Gil, P. Marucco, J.C. van de Zande, D. Nuyttens, A. Herbst, M. Gallart, Field-crop-sprayer potential drift measured using test bench: Effects of boom height and nozzle type, Biosystems Engineering 154 (2017) 3-13. DOI: <https://doi.org/10.1016/j.biosystemseng.2016.10.015>
- [41] Telescope holder. Available from: <http://galaktikaru.ru/wp-content/uploads/2012/09/27.jpg>
- [42] Telescope mount Altazimuth. Available from: <https://www.hotpng.com/free-png-clipart-tzhzc>
- [43] M. Al Heidary, J.P. Douzals, C. Sinfort, A. Vallet, Influence of spray characteristics on potential spray drift of field crop sprayers: A literature review, Crop Protection 63 (2014) 120-130. DOI: <https://doi.org/10.1016/j.cropro.2014.05.006>
- [44] P. Ziarati, V. Vambol, S. Vambol, Use of inductively coupled plasma optical emission spectrometry detection in determination of arsenic bioaccumulation in *Trifolium pratense* L. from contaminated soil, Ecological Questions 31/1 (2020) 15-22. DOI: <https://doi.org/10.12775/EQ.2020.003>
- [45] A. Shulha, V. Pavlykivskyi, O. Khramtsov, L. Borysova, Case study of socio-legal conditionality of establishing a ban on criminal acts concerning land resources, Ecological Questions 32/1 (2021) 1-18. DOI: <https://doi.org/10.12775/EQ.2021.006>
- [46] O. Kruzhilko, V. Maystrenko, V. Kalinchyk, Y. Polukarov, L. Mitiuk, N. Bilotserkivska, L. Borysova, T. Kachur, Development of the effective information and analytical support of the OSH management system, Journal of Achievements in Materials and Manufacturing Engineering 99/2 (2020) 72-84. DOI: <https://doi.org/10.5604/01.3001.0014.1777>



© 2020 by the authors. Licensee International OCSCO World Press, Gliwice, Poland. This paper is an open access paper distributed under the terms and conditions of the Creative Commons Attribution-NonCommercial-NoDerivatives 4.0 International (CC BY-NC-ND 4.0) license (<https://creativecommons.org/licenses/by-nc-nd/4.0/deed.en>).